

SPECIFICATION

产品规格书

Customer(客户): _____
Part No.(型号): CM28XX
Description(描述): 镜面铝COB
Date(日期): _____

Customer Approved (客户审核)	Approved (确认)	
Xuyu Approved (旭宇审核)	Approved (确认)	Issued (制定)
<input type="checkbox"/> Sample (样品)		<input type="checkbox"/> Mass Product (量产供货)

XUYU OPTOELECTRONICS CO.,LTD.

Address: A1 Building, Sunshine Industrial Park, Hezhou, Xixiang, Bao'an District Shenzhen City, Guangdong Province

地址: 广东省深圳市宝安区西乡鹤洲阳光工业区A1栋

Tel 电话: 0755-81453318-3328/3338

Fax 传真: 0755-81453199

网址: <http://www.xuyuled.com>

目录

Features 特性.....	2
Applications 产品应用.....	2
Package Dimensions 产品外观尺寸.....	3
Product coding rules 产品编码规则.....	4
Typical Electrical/Optical Characteristic 典型光电参数.....	5
Electrical-Optical Characteristics (Ta=25°C) 光电特性.....	6
Typical Electrical/Optical Characteristic Curves 典型光电特性曲线.....	7/8
CIE Chromaticity Diagram CIE 色度图.....	9/10
Packaging Specifications 包装规格.....	11
CAUTIONS 注意事项.....	12

◆ Features 特性:

- *Size(mm): 28*28*1.55 尺寸 (mm) : 28*28*1.55
- *Specular aluminium substrates and silicone package 镜面铝基板封装
- *Viewing Angle: 120° 发光角度: 120°
- * High reliability 高可靠性
- * RoHS compliant 通过 RoHS 认证

◆ Applications 产品应用:

- * Spotlight 射灯
- * Downlight 筒灯
- * Par lamp PAR 灯
- * Bulb 球泡灯 Restaurant lights 餐厅灯 Outdoor landscape lighting 户外景观照明

◆ Package Dimensions 产品外观尺寸

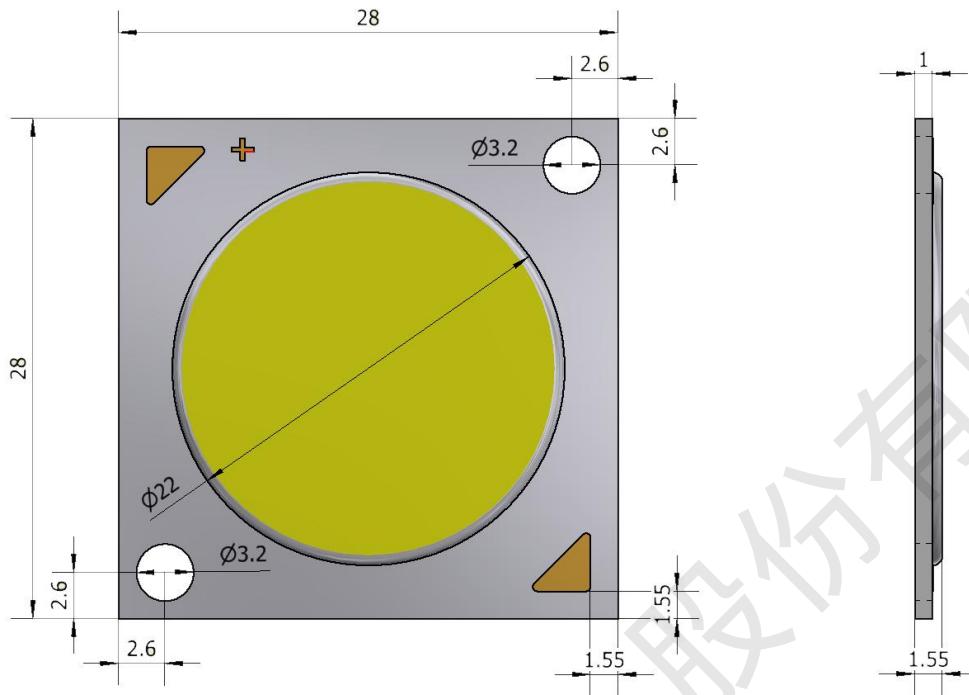

Notes:

1. All dimensions are in mm 所有尺寸单位为毫米。
2. Tolerance is ± 0.2 mm unless otherwise noted. 非特殊标注，公差为 ± 0.2 毫米。

◆ Product coding rules 产品编码规则

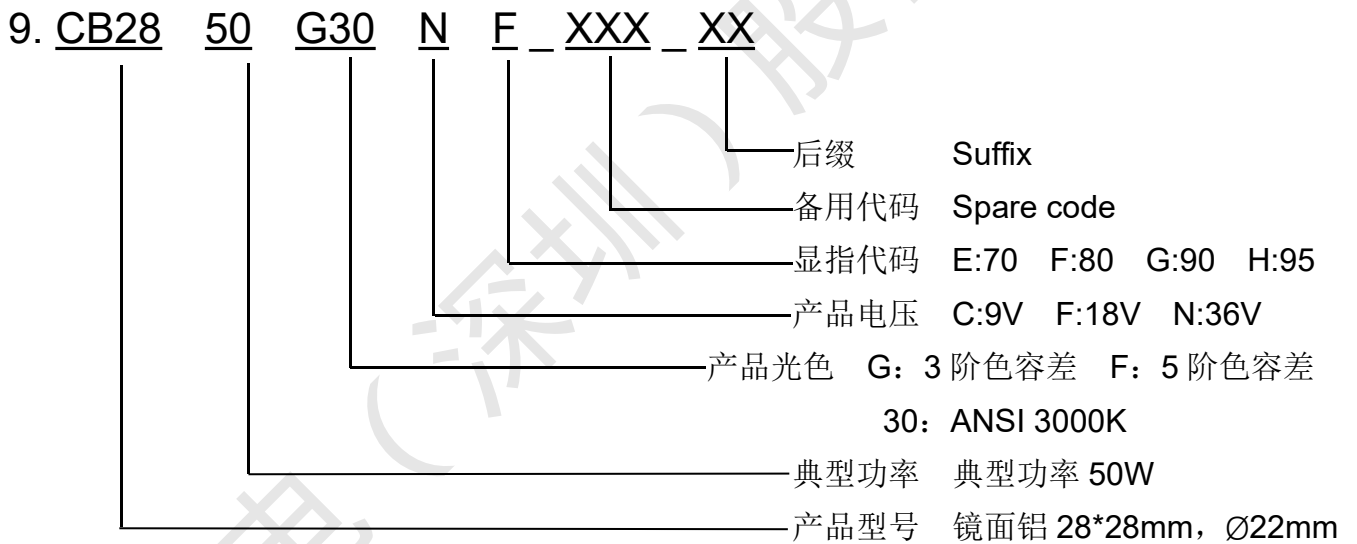
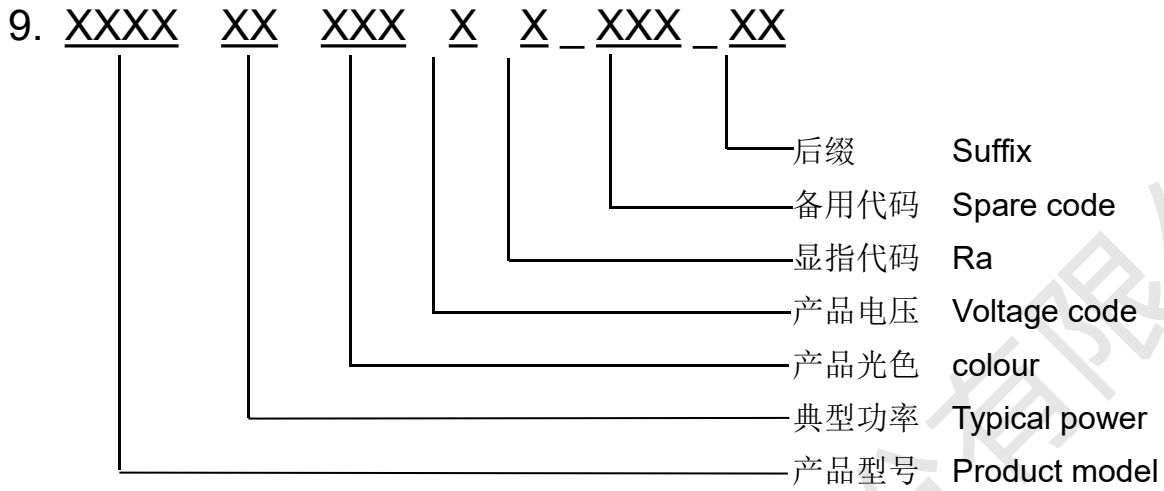

◆ Typical Electrical/Optical Characteristic 典型光电参数

Product	Light Emitting Surface (LE S)	Substrate Width	Voltage Options	Max Power (W)	Binning I/V	Typical Lumens (@Binning Current, 4000K CCT, 80 CRI)	Typical Lumens per Watt (@Binning Current, 4000K CCT, 80 CRI)	Typical Lumens ² (@Binning Current 3000K CCT, 90 CRI)	Typical Lumens per Watt ² (@Binning Current, 3000K CCT, 90 CRI)
CM2850	22 mm	28 mm	36 V	75 W	1400 mA/36 V	8000	155	7050	135
CM2890	22 mm	28 mm	54V	90W	1600mA/54V	13500	150	1150	130

◆ Electrical-Optical Characteristics (Ta=25°C) 光电特性

CM2850

Parameter	Symbol	Rating	Unit
Power Dissipation (功耗)	PD	50	W
Forward Current (正向电流)	IF	1400	mA
Max Forward Current (最大正向电流)	MAX IF	2000	mA
Peak Forward Current* (脉冲峰值电流)	IFP	2200	mA
Junction temperature (有限最高结温)	Tj	125	°C
Operation Temperature Range (工作温度)	Topr	-30 to +85	°C
Storage Temperature Range (贮藏温度)	Tstg	-40 to +80	°C
Thermal resistance (有效热阻参考)	RJ-B	0.32	°C/W
ESD Sensitivity (HBM) (抗静电级别)	--	4000	V
Hand Soldering Temperature (手工焊接温度)	350±20°C/3~5sec		

CM2890

Parameter	Symbol	Rating	Unit
Power Dissipation (功耗)	PD	90	W
Forward Current (正向电流)	IF	1600	mA
Max Forward Current (最大正向电流)	MAX IF	2400	mA
Peak Forward Current (脉冲峰值电流)	IFP	2500	mA
Junction temperature (有限最高结温)	Tj	125	°C
Operation Temperature Range (工作温度)	Topr	-30 to +85	°C
Storage Temperature Range (贮藏温度)	Tstg	-40 to +80	°C
Thermal resistance (有效热阻参考)	RJ-B	0.16	°C/W
ESD Sensitivity (HBM) (抗静电级别)	--	4000	V
Hand Soldering Temperature (手工焊接温度)	350±20°C/3~5sec		

Note: the test tolerance 测试公差

$V_F : \pm 1\%$

$XY : \pm 0.003$

$\Phi_e : \pm 10\%$

◆ Typical Electrical/Optical Characteristic Curves 典型光电特性曲线

CM2850

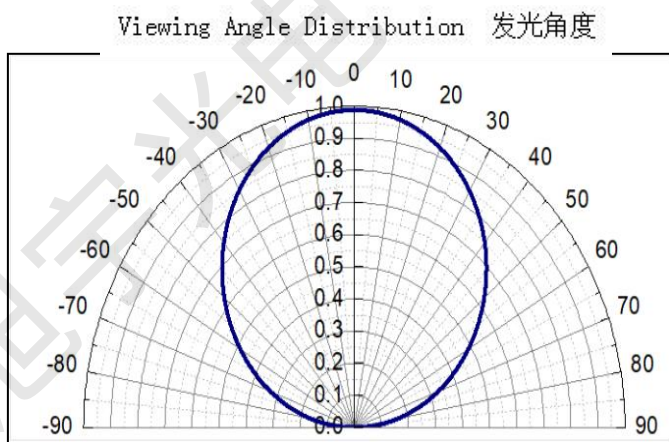
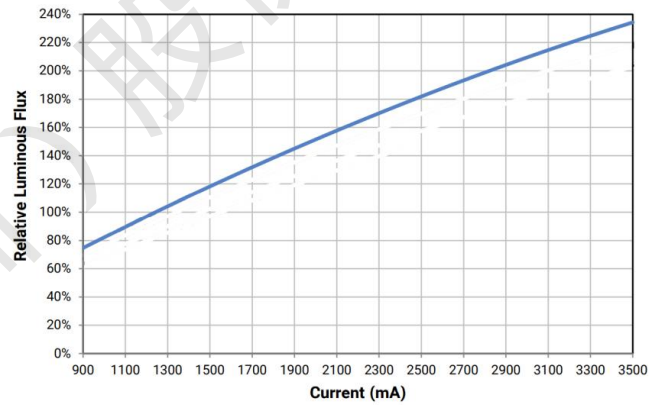
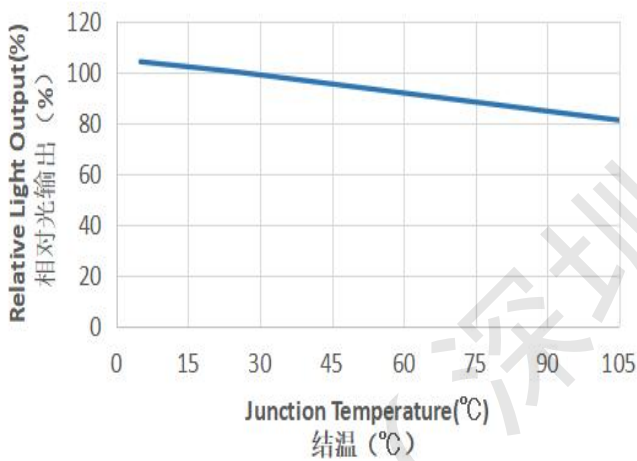
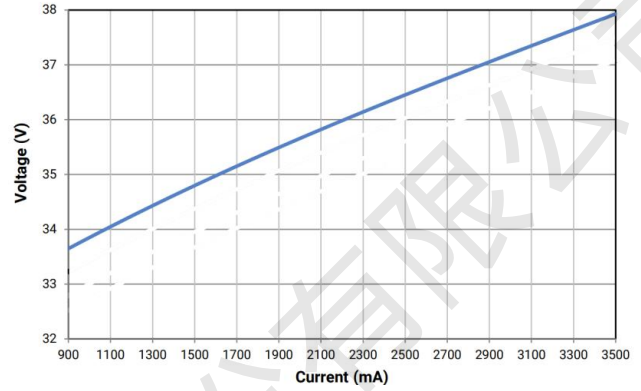
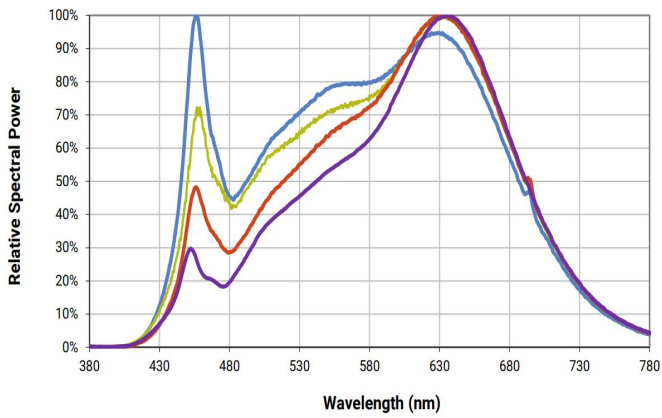

Notes:

1. Related to the temperature test based on the right current. 与温度相关测试基于额定电流。
2. All measurements were made under the standardized environment of XUYU. 所有测试都是基于旭宇光电（深圳）股份有限公司现有的标准测试平台。

◆ Typical Electrical/Optical Characteristic Curves 典型光电特性曲线

CM2890

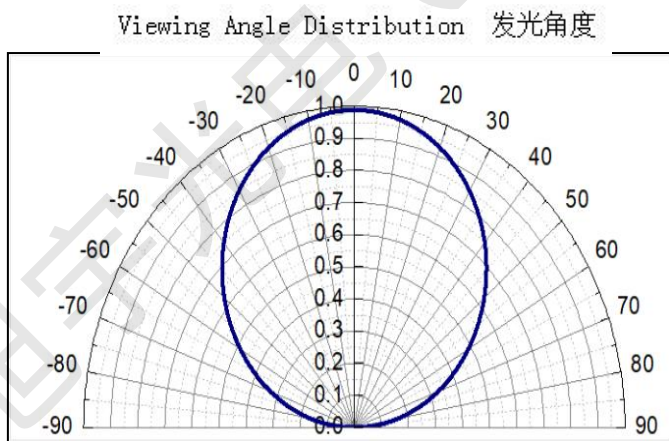
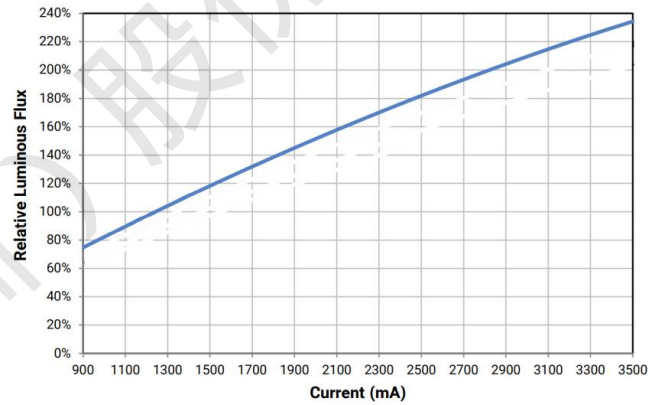
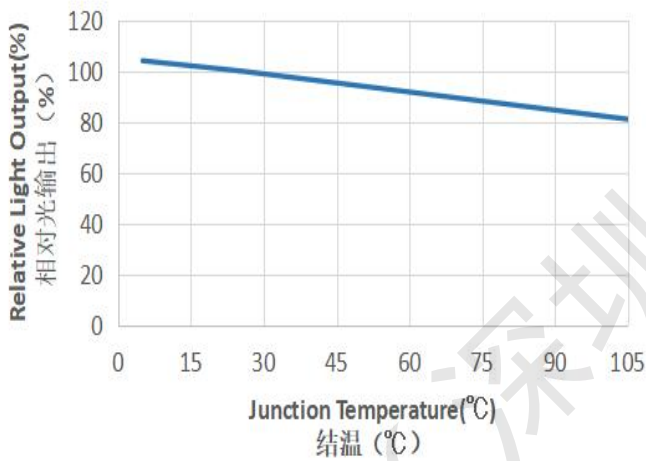
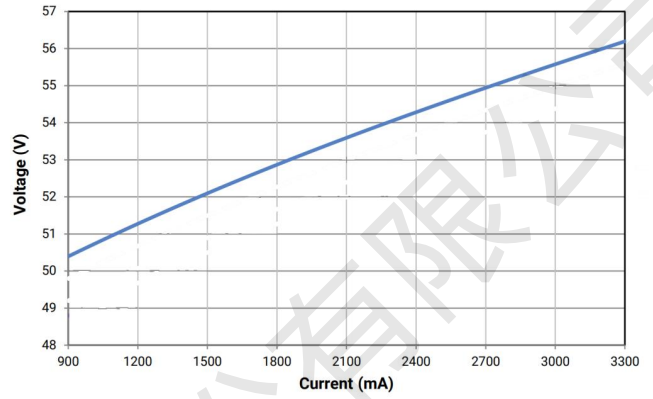
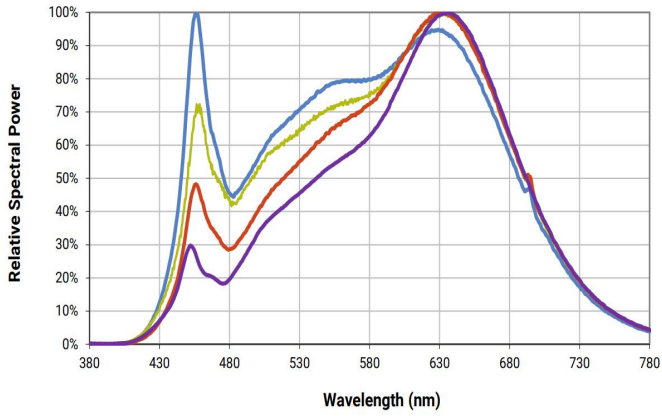

Notes:

1. Related to the temperature test based on the right current. 与温度相关测试基于额定电流。
2. All measurements were made under the standardized environment of XUYU. 所有测试都是基于旭宇光电（深圳）股份有限公司现有的标准测试平台。

◆CIE Chromaticity Diagram:(TA=25°C)

CIE 色度图

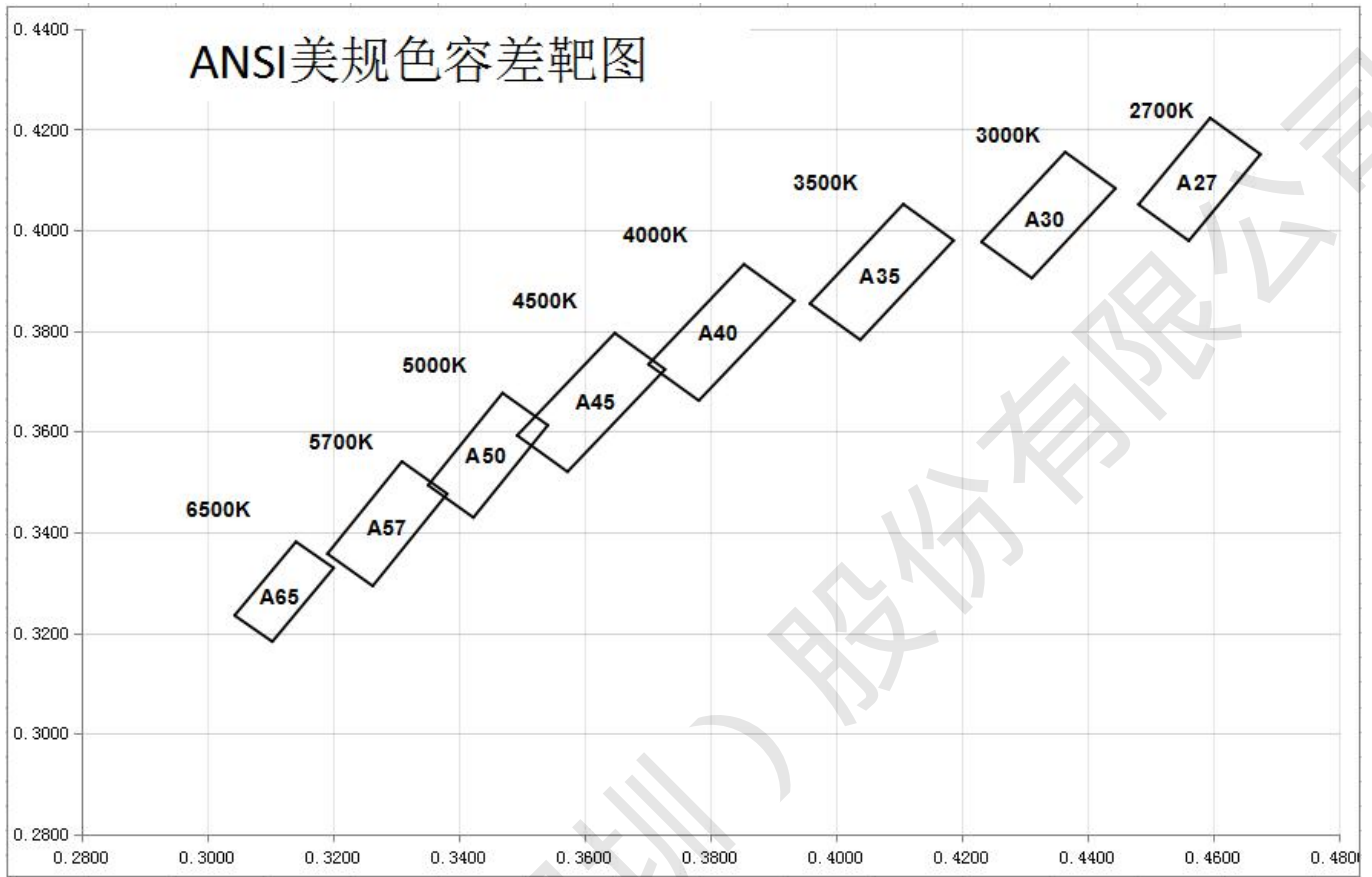

Color Rank :(TA=25℃) 分 Bin 规格

CODE	CCT	X	Y
A27	2700K	0.4595	0.4223
		0.4481	0.4051
		0.4561	0.3979
		0.4675	0.4151

CODE	CCT	X	Y
A30	3000K	0.4365	0.4155
		0.4231	0.3977
		0.4311	0.3905
		0.4445	0.4083

CODE	CCT	X	Y
A35	3500K	0.4107	0.4052
		0.3959	0.3854
		0.4039	0.3782
		0.4187	0.3980

CODE	CCT	X	Y
A40	4000K	0.3854	0.3932
		0.3702	0.3734
		0.3782	0.3662
		0.3934	0.3860

CODE	CCT	X	Y
A45	4500K	0.3649	0.3796
		0.3493	0.3592
		0.3573	0.3520
		0.3729	0.3724

CODE	CCT	X	Y
A50	5000K	0.3470	0.3677
		0.3352	0.3493
		0.3424	0.3429
		0.3542	0.3613

CODE	CCT	X	Y
A57	5700K	0.3310	0.3541
		0.3192	0.3357
		0.3264	0.3293
		0.3382	0.3477

CODE	CCT	X	Y
A65	6500K	0.3142	0.3381
		0.3044	0.3235
		0.3104	0.3183
		0.3202	0.3329

◆ Packaging Specifications 包装规格

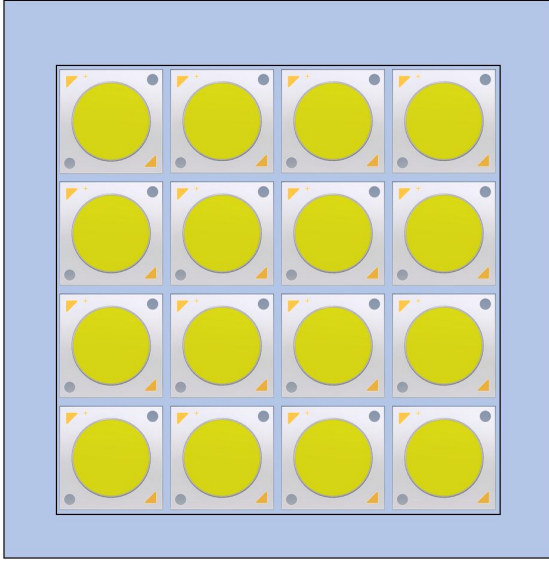

Packaging specifications 包装规格 16PCSx4

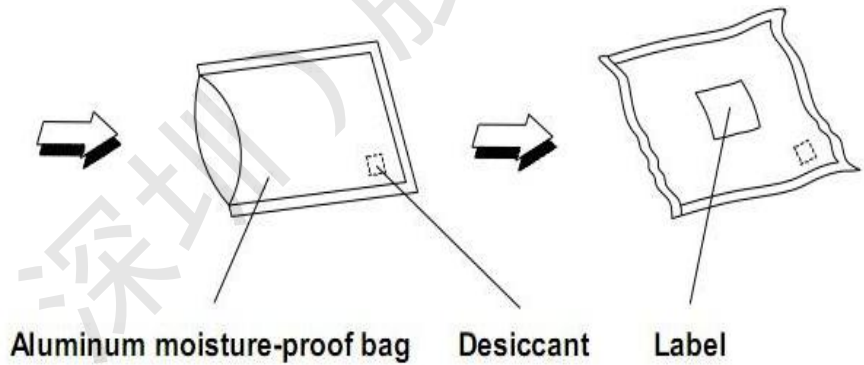
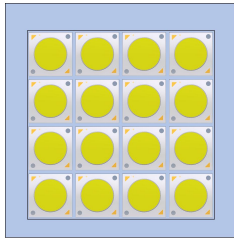

Label (标签)

Part NO: 产品型号 Product model

LOT NO: 指令单号 Instruction number

IV/PO: 光通量/功率 Luminous flux /Power

V_F/I_F: 电压/电流 Voltage /Electric current

CCT/XY: 色温/色区 Color temperature / Color Coordinates

R_a/SD/R₉: 显色指数/色容差/饱和红色度 Color Rendering index/Color tolerance /R₉

Q'ty: 数量 Quantity

Date: 日期 Date

Code: 产品代码 Product code



◆ CARTIONS 注意事项

一、Storage/use 储存/使用:

1. In order to avoid moisture absorption, it is suggested to store the products in a drying cabinet with desiccant. The storage temperature is $5^{\circ}\text{C}\sim 30^{\circ}\text{C}$, and the humidity is $\leq 60\%HR$

1. 为避免吸潮建议将产品贮存在放有干燥剂的干燥柜中，贮存温度为： $5^{\circ}\text{C}\sim 30^{\circ}\text{C}$ ，湿度： $\leq 60\%HR$ 。

2. The encapsulated material of the LEDs is silicone. Therefore the LEDs have a soft surface on the top of package. The pressure to the top surface will be influence to the reliability of the LEDs. Precautions should be taken to avoid the strong pressure on the encapsulated part. So when use the picking up nozzle, the pressure on the silicone resin should be proper.

2. LED 封装为硅胶，故 LED 胶体表面较软，用力按压胶体表面会影响 LED 可靠性。应避免使用较大压力按压胶体表面，在使用吸嘴时，作用于胶体表面的力应适宜。

3. Handle the component along the side surface by using forceps or appropriate tools; do not directly touch or Handle the silicone lens surface, it may damage the internal circuitry.

3. 采用合适的工具从侧面夹取材料，不要用手或尖锐金属按压胶体表面，否则可能导致内部电路损坏。

4. Electrostatic protection. LED is a chip sensitive electronic component. Various measures should be taken to avoid static electricity, such as wearing an electrostatic bracelet or anti-static gloves during use. All devices, equipment and instruments should be well grounded.

4. 静电防护。LED 是晶片敏感电子元器件，应采取各种措施避免静电，诸如在使用过程中戴静电手环或防静电手套。所有的装置、设备仪器应良好接地。